

THERMOSTATIC HEADS



Art. 1824
 Thermostatic head with built-in sensor with liquid-filled element.
 - Temperature range: from 0°C to 28°C



Art. 1827
 Chrome-plated thermostatic head. Built-in sensor with liquid-filled element.
 - Temperature range: from 0°C to 28°C

1. DESCRIPTION

The FAR thermostatic head automatically adjusts room temperature by means of a sensor with a liquid-filled element, which detects temperature variations and opens, or closes the valve on which it is installed. By setting the selector at the desired value (from 0 to 5) you can maintain

the corresponding room temperature within $\pm 2^\circ\text{C}$. The combination of valve and thermostatic head meets the requirements of European Standard UNI EN 215:2007 "THERMOSTATIC VALVES FOR RADIATORS – REQUIREMENTS AND TEST METHODS." It is a low thermal inertia solution.



SELECTOR POSITION	CORRESPONDING TEMPERATURE (°C)
0	WITHOUT RADIATOR
☸	7
1	12
2	16
3	20
4	24
5	28

2. CONSTRUCTION FEATURES

The combination of construction features offers further advantages:

- **Fast, easy installation** thanks to the new system with locking ring
- **Locking lever** which ensures that the head stays in position once installed
- **Compact sizes** which make for easier installation even in confined spaces

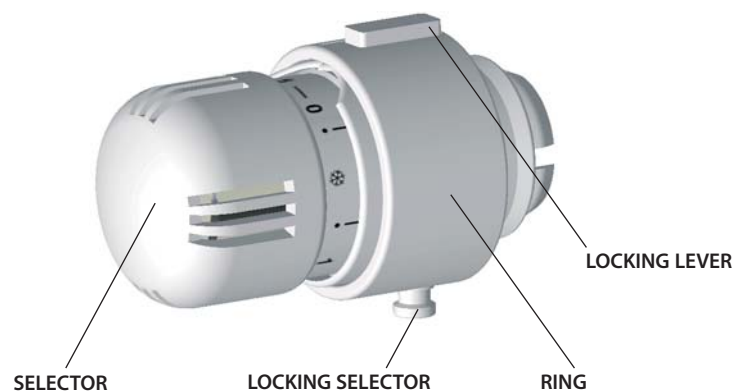

3. INSTALLATION OF Art. 1824



1. Unscrew the manual regulating valve

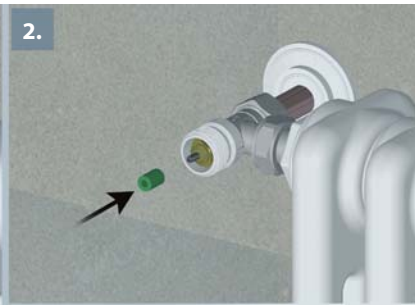

2. Insert the green extractor onto the steel pin

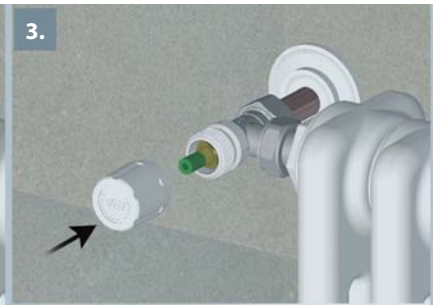

3. Tighten the manual regulating valve

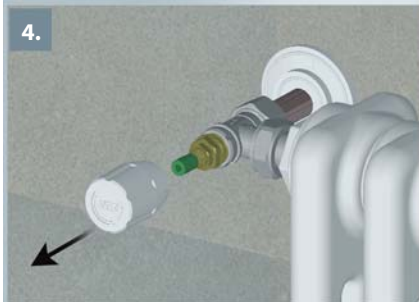

4. Take out the threaded plastic support

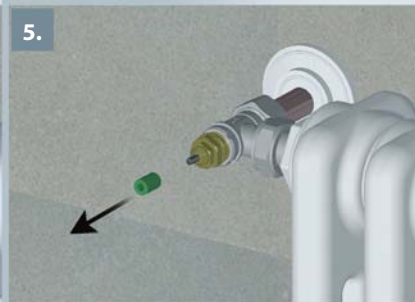

5. Remove the green extractor from the pin

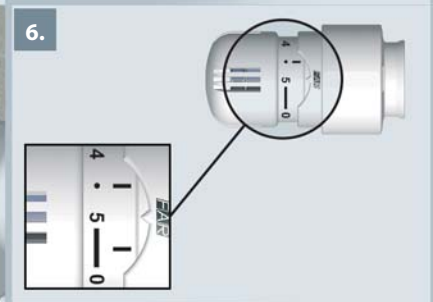

6. Set the temperature selector on 5

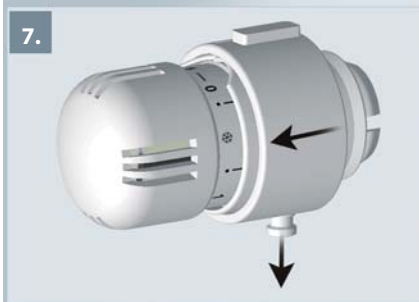

7. Pull down the ring towards the selector and the locking lever downward



8. Locate the head as shown in the picture by aligning the grooves

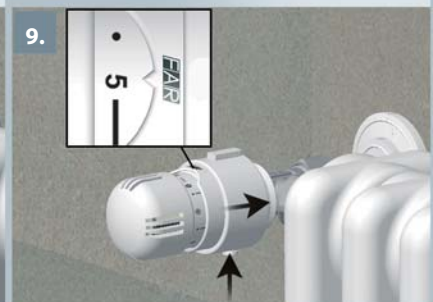

9. Push the ring up towards the valve, so that the complete FAR logo is visible and press the locking lever

3.1 INSTALLATION OF Art. 1827 ON TOP VALVES

1. Unscrew the manual regulating valve and the support in chrome plated brass, removing them from the valve body
2. Set the numbered temperature selector on 5
3. Pull down the ring towards the selector and the locking lever downward
4. Locate the head as shown in the picture by aligning the grooves
5. Push the ring up towards the valve, so that the complete FAR logo is visible and press the locking lever



1.

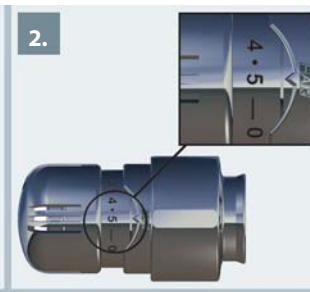

2.

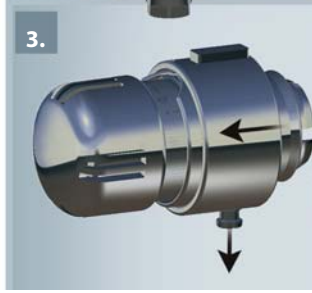

3.

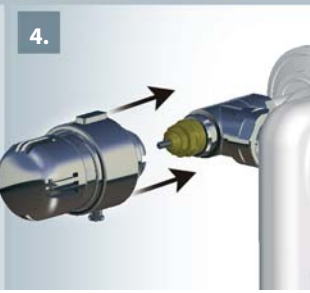

4.

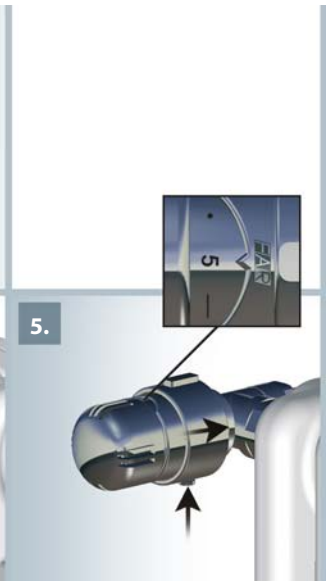

5.

Installation overview

Thermostatic heads can be installed in a variety of positions with the use of FAR thermostatic valves, which offer solutions to match all types of application.

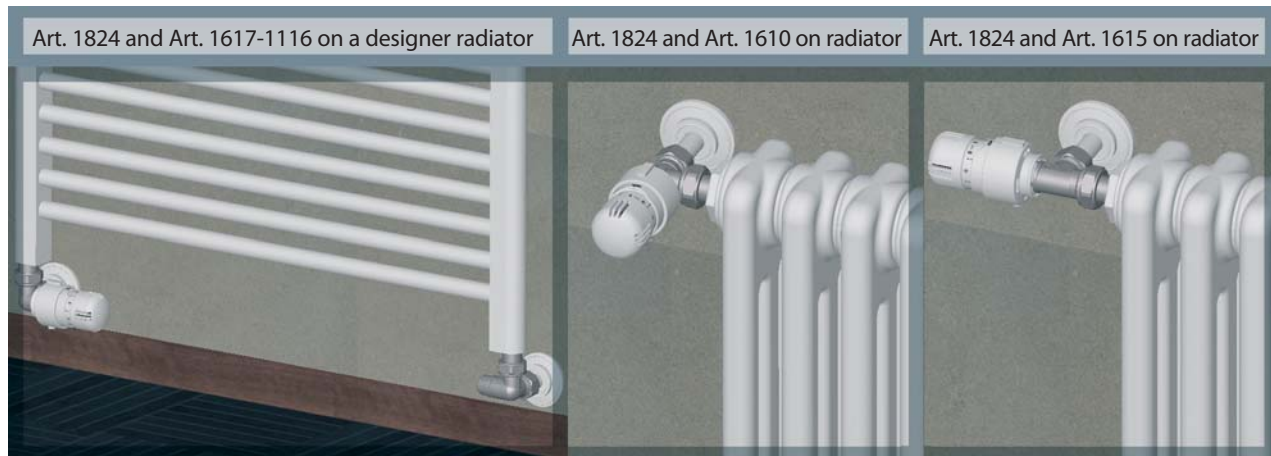

4. REMOTE THERMOSTATIC HEAD

To guarantee accurate temperature sensing and regulation - even in situations where heat emitters are affected by other factors within the room - FAR offers two further systems for monitoring room temperature:



Art. 1800
Thermostatic head with sensor and graduated scale for selection of remote temperature value.

The sensor, which features a graduated temperature scale, is wall-mounted in the vicinity of the heat emitter, but remote from it by up to 2m. It should be located in an open area with no barriers to free movement of room air.

This product is suitable for use with heat emitters located in recesses, or concealed within decorative cabinets, or behind curtains of thick material where free circulation of room air is inhibited.

Main features

- Thermostatic head with built-in sensor with liquid-filled element
- Remote selector numbered from 1 to 5
- Length of capillary: 2 m
- Temperature range: 0° ÷ 28° C (Temperature values are standard for all thermostatic models - see listing in the Table for Art. 1824)



Art. 1810
Thermostatic head and remote sensor

The sensor is located at a maximum distance of 2m, usually on the skirting board under the heat emitter, in such a way as to be in the airflow drawn by the radiator or convector itself, which will average the temperature of room air as a whole. It should be located in an open area with no barriers to free movement of room air.

This product is also suitable for use with heat emitters located in recesses, or concealed within decorative cabinets, or behind curtains of thick material where free circulation of room air is inhibited.

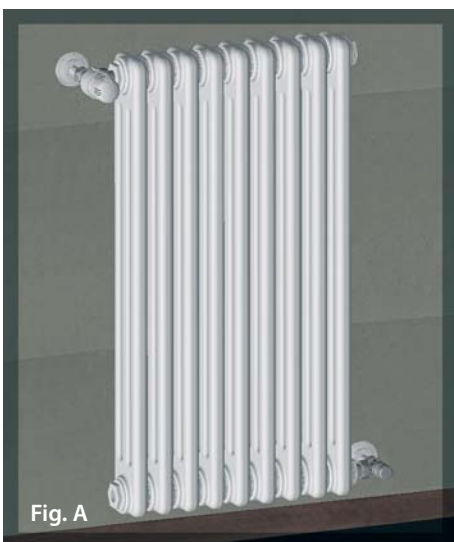

Fig. A

In the following illustrations you can see how the radiator - installed on the free wall (Fig. A) - permits installation of Art. 1824, as the sensor is in contact with circulating air and there are no special materials, which might influence the recorded temperature. On the other hand, if the radiator is installed in a recess (Fig. B) or in presence of furniture, which could interfere with the exact measurement of temperature near the heat emitter, FAR recommends application of Art. 1800 or Art. 1810.



Fig. B

5. ANTI-TAMPERING PROTECTION FOR THERMOSTATIC HEAD, Art. 1824

The anti-tampering protection device, Art. 1832, makes it possible to lock the FAR thermostatic head securely at the preset temperature value and to prevent interference by unauthorised persons.

<p>Preset the desired value and lock the temperature selector with the key inserted into the head.</p>	<p>Insert the anti-tampering device in the correct position as shown in the illustration</p>	<p>Check the correct insertion of locking key into anti-tampering slot</p>
<p>Insert the locking nut into the seat</p>	<p>Tighten with reversible Allen key the screw in such a way as to lock anti-tampering device</p>	

6. TECHNICAL FEATURES

Max. differential pressure: 1 bar
Reference point: 3 = 20° C
Max. room temperature: 50° C
Temperature range: 7-28° C
Antifreeze operation: 7° C
Hysteresis: 0,35 K
Proportional band: 2 K
Response time - 6.4.1.13 EN215 point: 23 min.

7. DIMENSIONAL FEATURES

<table border="1"> <thead> <tr> <th>CODE</th> <th>A</th> <th>B</th> <th>C</th> <th>D</th> <th>E</th> </tr> </thead> <tbody> <tr> <td>1800</td> <td>36</td> <td>83</td> <td>79</td> <td>79</td> <td>50</td> </tr> </tbody> </table>	CODE	A	B	C	D	E	1800	36	83	79	79	50	<table border="1"> <thead> <tr> <th>CODE</th> <th>A</th> <th>B</th> <th>C</th> <th>D</th> <th>E</th> </tr> </thead> <tbody> <tr> <td>1810</td> <td>98</td> <td>55</td> <td>85</td> <td>33</td> <td>27</td> </tr> </tbody> </table>	CODE	A	B	C	D	E	1810	98	55	85	33	27	<table border="1"> <thead> <tr> <th>CODE</th> <th>A</th> <th>B</th> </tr> </thead> <tbody> <tr> <td>1824</td> <td>86</td> <td>48</td> </tr> <tr> <td>1827</td> <td>86</td> <td>48</td> </tr> </tbody> </table>	CODE	A	B	1824	86	48	1827	86	48
CODE	A	B	C	D	E																														
1800	36	83	79	79	50																														
CODE	A	B	C	D	E																														
1810	98	55	85	33	27																														
CODE	A	B																																	
1824	86	48																																	
1827	86	48																																	